

Perrin Tube S 1000616

Instruction sheet

10/15 ALF

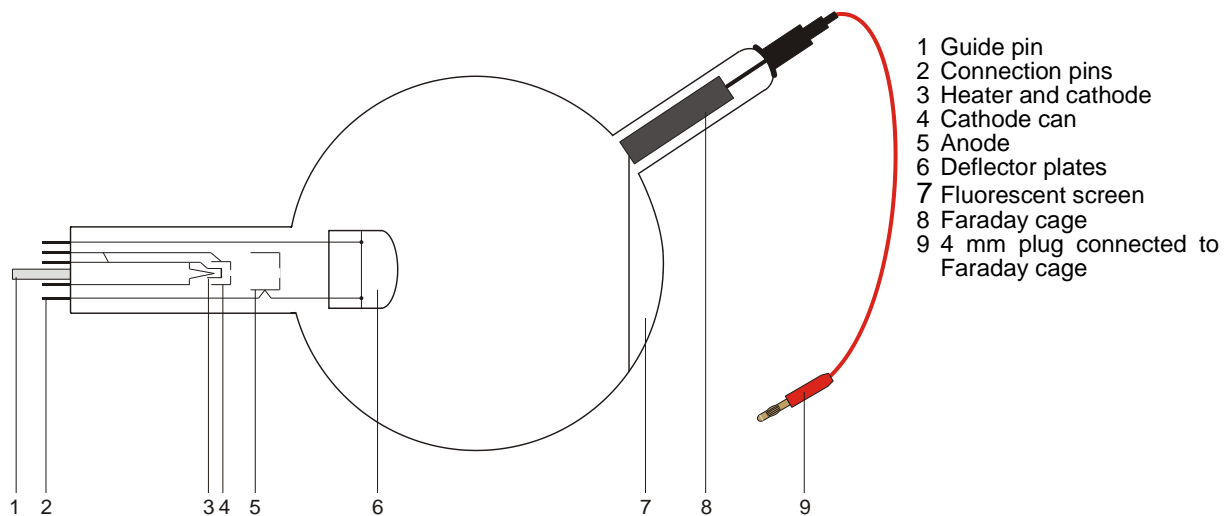

1. Safety instructions

Hot cathode tubes are thin-walled, highly evacuated glass tubes. Treat them carefully as there is a risk of implosion.

- Do not subject the tube to mechanical stresses.
- Do not subject the connection leads to any tension.
- The tube only may be used with tube holder S (1014525).

If voltage or current is too high or the cathode is at the wrong temperature, it can lead to the tube becoming destroyed.

- Do not exceed the stated operating parameters.
- Only use safety experiment leads for connecting circuits.
- Only change circuit with power supply equipment switched off.
- Only exchange tubes with power supply equipment switched off.

When the tube is in operation, the stock of the tube may get hot.

- If necessary, allow the tube to cool before dismantling.

The compliance with the EC directive on electromagnetic compatibility is only guaranteed when using the recommended power supplies.

2. Description

The Perrin tube serves to demonstrate the negative polarity of electrons and to estimate the specific electron charge e/m by magnetic deflection into a Faraday cage, which is connected to an electroscope. It is also possible to investigate the deflection of electrons in two perpendicular magnetic alternating fields or by collinear electric and magnetic alternating fields (Lissajous figures).

The Perrin Tube is a highly evacuated tube with an electron gun, consisting of an oxide cathode heated indirectly via a heating coil, a cylindrical anode and pair of deflector plates contained in a clear glass bulb, partly coated with a fluorescent screen. The electrons emitted by the electron gun form a narrow circular beam that can be seen as a spot on the fluorescent screen. A glass tube with a Faraday cage is set on the glass bulb at about 45° to the undeflected beam.

3. Technical data

Filament voltage:	≤ 7.5 V AC/DC
Anode voltage:	2000 V to 5000 V
Anode current:	typ. 0.18 mA at $U_A = 4000$ V
Beam current:	4 μ A at $U_A = 4000$ V
Plate voltage:	50 to 350 V
Glass bulb:	130 mm dia. approx.
Total length:	260 mm approx.

4. Operation

To perform experiments using the Perrin tube, the following equipment is also required:

1 Tube holder S	1014525
1 High voltage power supply 5 kV (115 V, 50/60 Hz)	1003309
or	
1 High voltage power supply 5 kV (230 V, 50/60 Hz)	1003310
1 Helmholtz pair of coils S	1000611
1 DC Power Supply 20 V, 5 A (115 V, 50/60 Hz)	1003311
or	
1 DC Power Supply 20 V, 5 A (230 V, 50/60 Hz)	1003312
1 Electroscope	1001027
1 Analogue multimeter AM50	1003073

4.1 Setting up the tube in the tube holder

The tube should not be mounted or removed unless all power supplies are disconnected.

- Press tube gently into the stock of the holder and push until the pins are fully inserted. Take note of the unique position of the guide pin.

4.2 Removing the tube from the tube holder

- To remove the tube, apply pressure with the middle finger on the guide pin and the thumb on the tail-stock until the pins loosen, then pull out the tube.

5. Example experiments

5.1 Evidence of the particle nature of cathode beam and establishment of their polarity

- Set up the experiment as in fig. 1.
- Apply a voltage to the anode between 2 kV and 5 kV.

On the fluorescent screen the cathode beams are visible as a round spot.

- Slowly increase the coil current until the electron beam is deflected into the Faraday cage. If necessary, reverse the direction of the coil current and turn the tube in the tube holder so that the beam falls within the end of the Faraday cage.

The electroscope will open to indicate the presence of a charge.

- Turn off the voltage to the heater filament and the anode.

The electroscope remains open.

If the charge on the Faraday cage were due to the cathode beam being some kind of wave radiation, the charge should disappear when the filament ceases to radiate. Because the experiment shows that the charge remains on the cage when the filament is cold, the conclusion must be that the beam comprises some constituent of matter which is electrically charged. These particles are called electrons.

The negative polarity of the cathode beam can be demonstrated if the electroscope is charged by rubbing a plastic or a glass rod (so that they are negatively and positively charged respectively).

5.2 Estimation of the specific electron charge e/m

- Set up the experiment as in fig. 3.

When the electron beam is deflected into the Faraday cage, the following applies to the specific charge e/m :

$$\frac{e}{m} = \frac{2 \cdot U_A}{(B \cdot r)^2} \quad (1)$$

U_A can be read out directly, the curvature radius r derives from the geometric data of the tube (bulb diameter 13 cm, Faraday cage at 45° to the beam axis) to $r = 16$ cm approx. (refer to fig. 2).

With the coils at Helmholtz-geometry and the coil current I , the following applies to the magnetic flux density B of the magnetic field

$$B = \left(\frac{4}{5}\right)^2 \cdot \frac{\mu_0 \cdot n}{R} \cdot I = k \cdot I \quad (2)$$

with $k =$ at good approximation 4.2 mT/A, $n = 320$ (no. of turns) and $R = 68$ mm (coil radius).

- Substitute U_A , r and B in equation 1 and calculate e/m .

5.3 Deflection in crossed magnetic alternating fields (Lissajous figures)

The following equipment is also required:

1 Auxiliary coil	1000645
1 AC/DC power supply 12 V, 3 A (115 V, 50/60 Hz)	1002775
or	
1 AC/DC power supply 12 V, 3 A (230 V, 50/60 Hz)	1002776
1 Function generator FG100 (115 V, 50/60 Hz)	1009956
or	
1 Function generator FG100 (230 V, 50/60 Hz)	1009957

- Set up the experiment as in fig. 5.
- Place the auxiliary coil on the tube holder as in fig. 4.

- Connect the auxiliary coil to the alternating current source.
- Connect the Helmholtz coils to the function generator and choose a sinusoidal wave form.
- Apply a voltage to the anode between 2 kV and 5 kV.
- Apply an alternating voltage up to 15 V to the auxiliary coil and observe the horizontal deflection.
- Set a frequency of e.g. 50 Hz at the function generator, vary the amplitude of the sine-signal and observe the Lissajous figures on the fluorescent screen.

5.4 Deflection in collinear alternating magnetic and electric fields

The following equipment is also required:

1 Function generator FG100 (115 V, 50/60 Hz)
1009956

or

1 Function generator FG100 (230 V, 50/60 Hz)
1009957

1 AC Power supply unit with an output of up to 250 V AC

Note: In this set-up the anode must be connected to ground potential!

Caution! Contact-hazardous voltages may be present at the connection field of the tube holder.

- Set up the experiment as in fig. 6.
- Connect the Helmholtz coils to the function generator and choose a sinusoidal signal.
- Apply a voltage to the anode between 2 kV and 5 kV.
- Apply an alternating voltage of about 200 V to the deflection plates and observe the horizontal deflection.
- Set a frequency of e.g. 50 Hz at the function generator, vary the amplitude of the sine-signal and observe the Lissajous figures on the fluorescent screen.

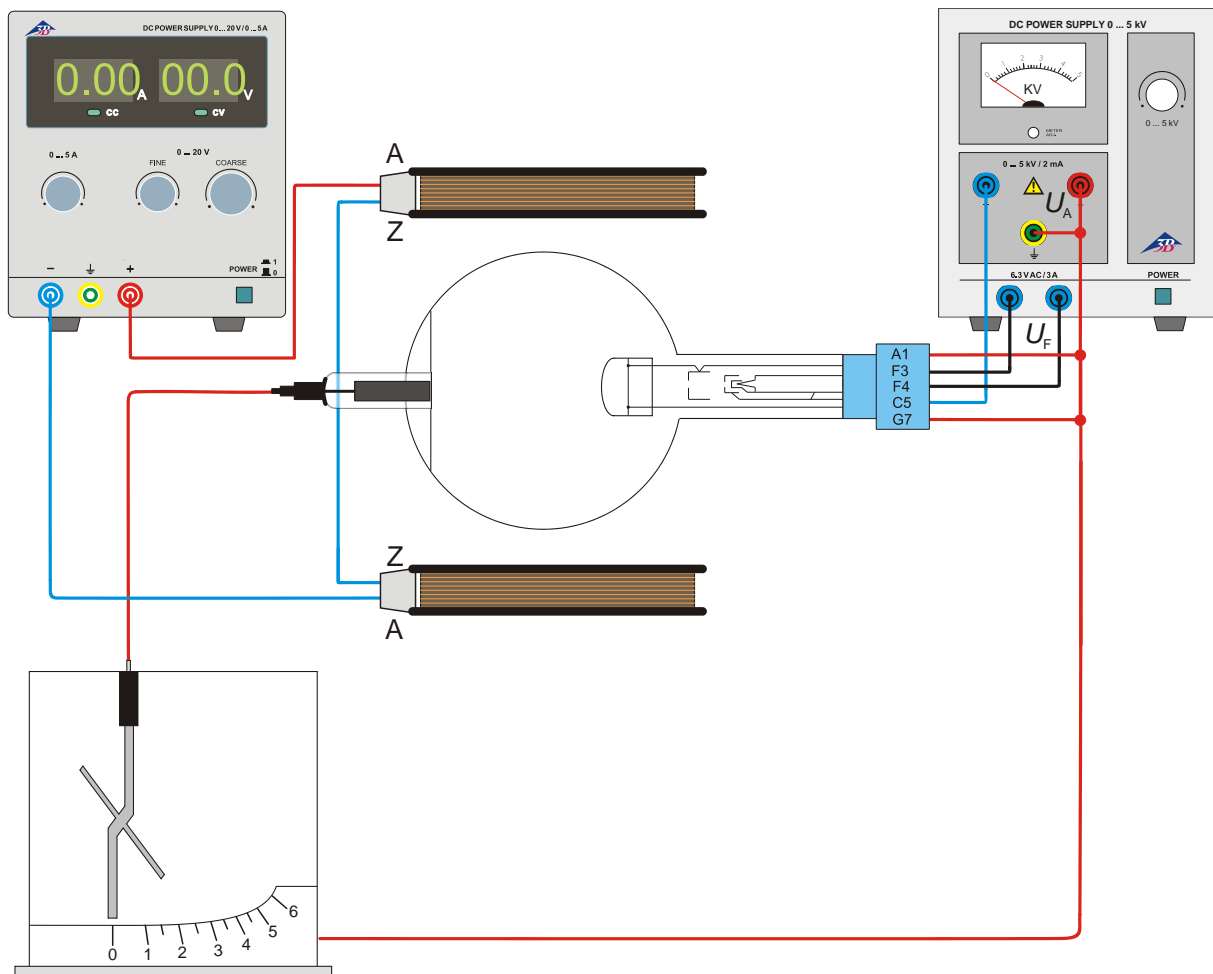

Fig. 1 Evidence of the particle nature of cathode beam and establishment of their polarity

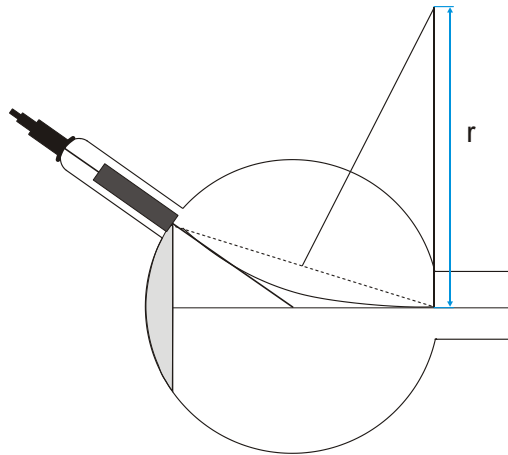

Fig. 2 Definition of the curvature radius r

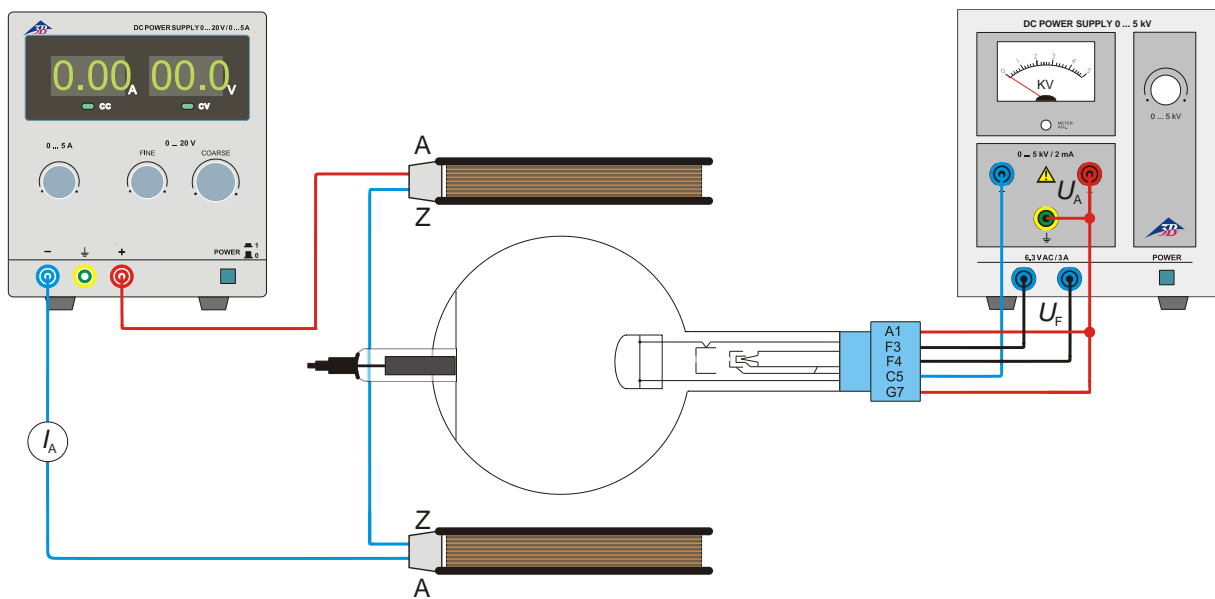

Fig. 3 Estimation of the specific electron charge e/m

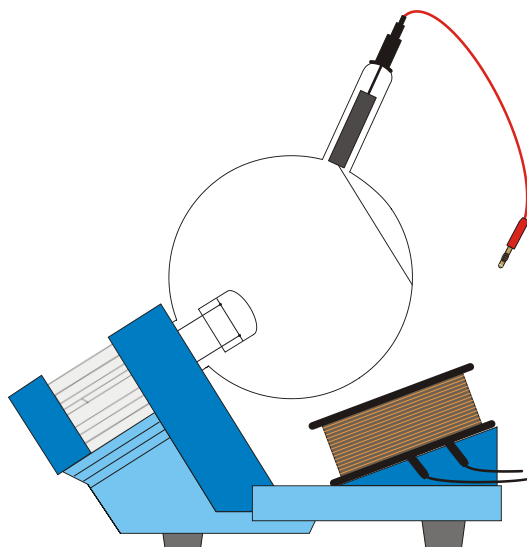

Fig.4 Set-up of the auxiliary coil

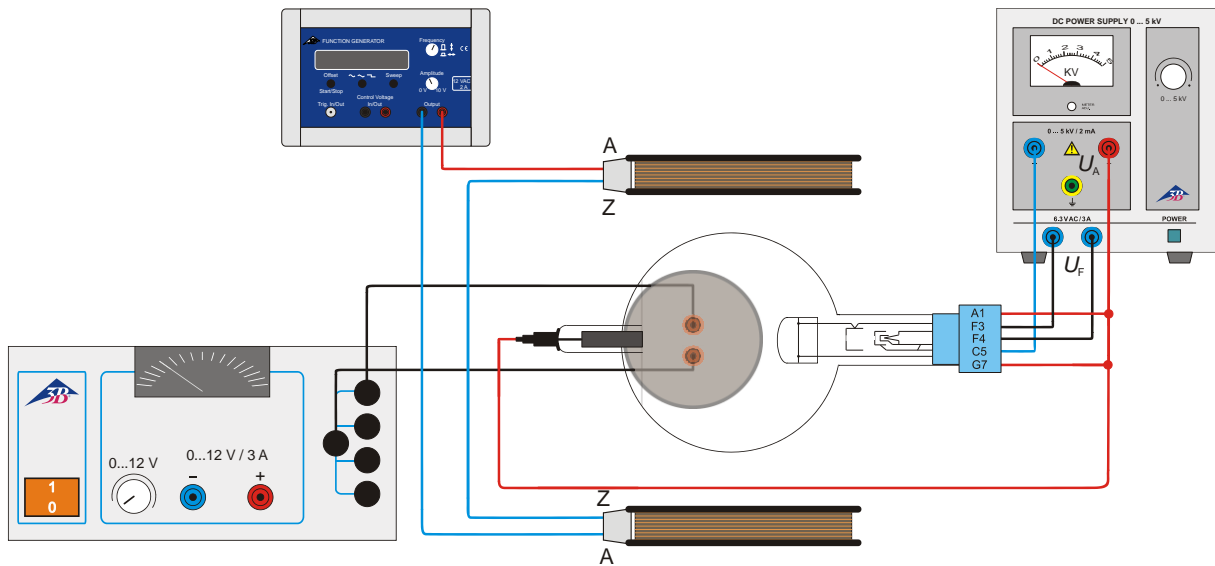

Fig.5 Deflection in crossed magnetic alternating fields (Lissajous figures)

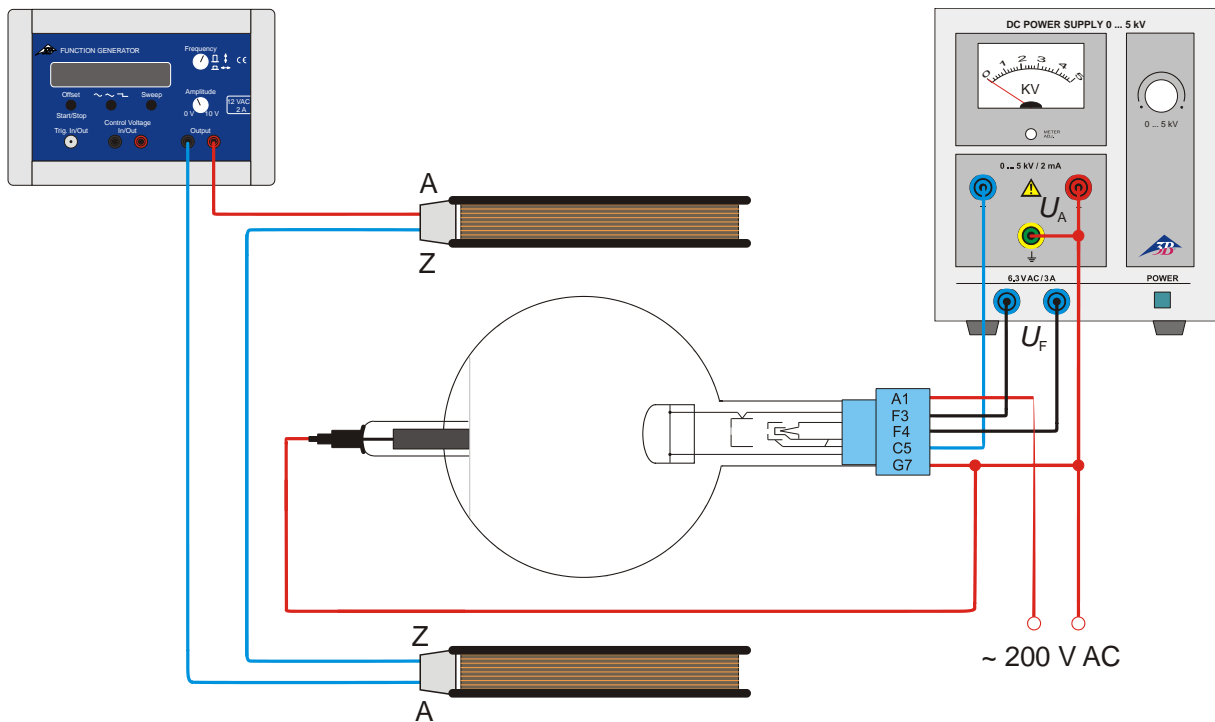

Fig 6 Deflection in collinear alternating magnetic and electric fields (Lissajous figures)

