

Code
W15127

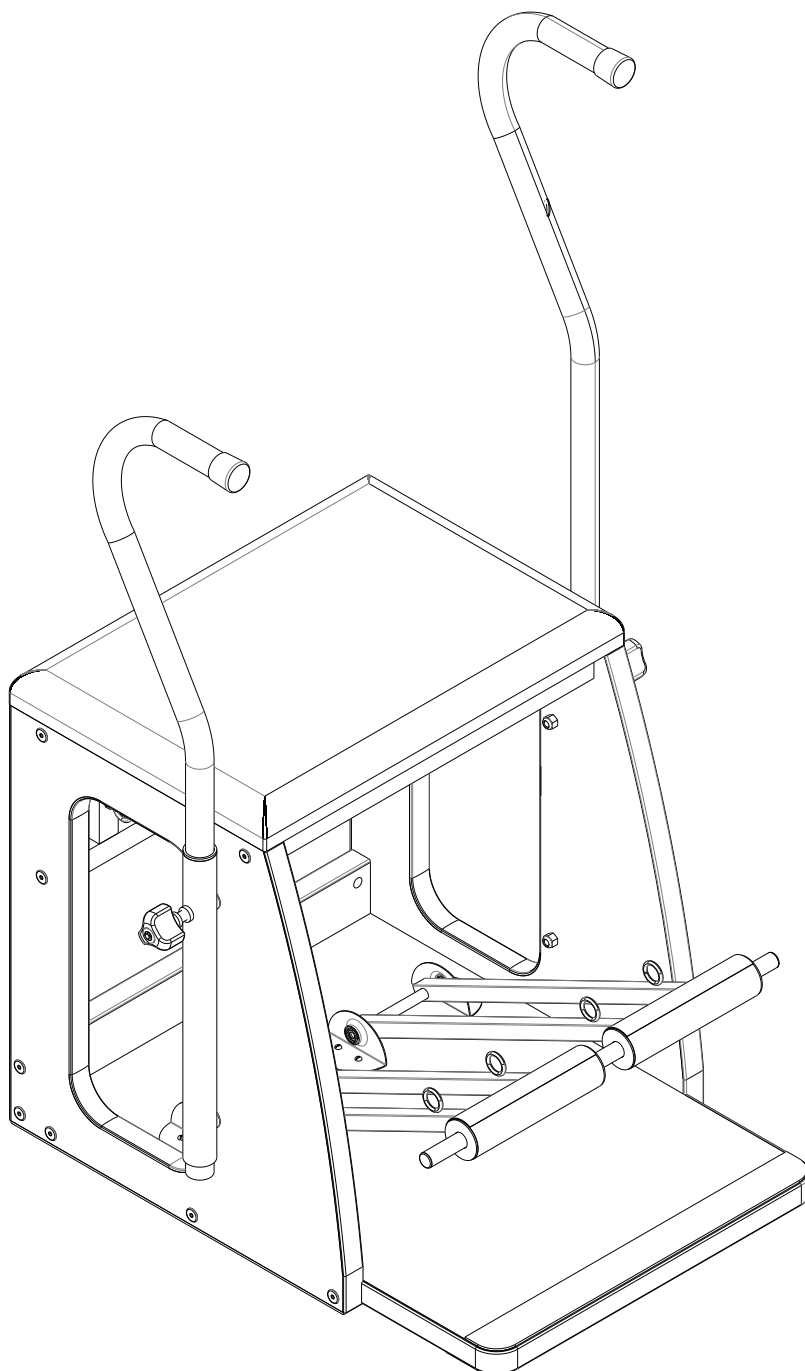

COMBO CHAIR - PILATES LINE



INTERNATIONAL DISTRIBUTOR
3B Scientific GmbH, Hamburg
Rudoffweg 8
21031 Hamburg
www.3bscientific.com

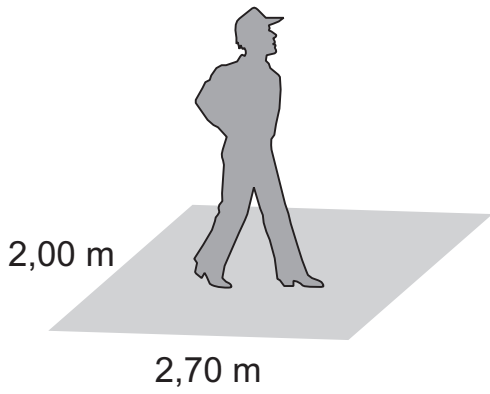

Max. 1,35 m
Min. 1,10 m

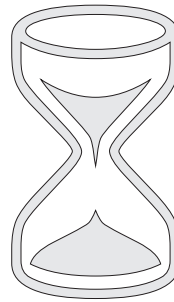
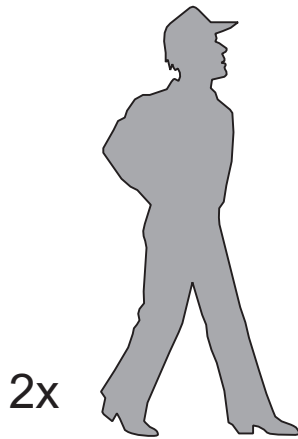
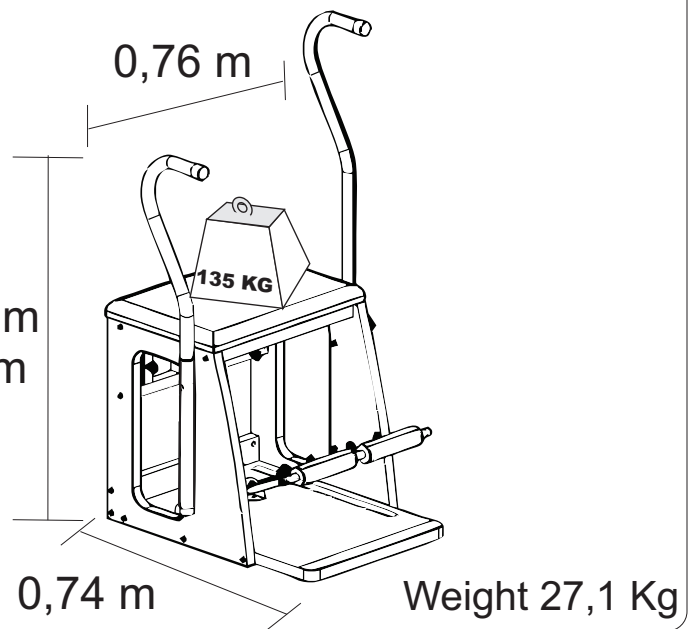

40 min.

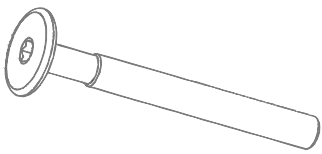

A
16x

Cab. Ø17 mm Ø 1/4"x 60mm

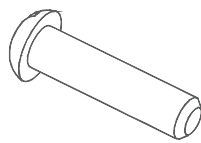

B
04x

Ø3/16x3/4mm

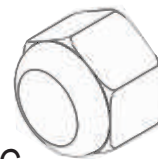

C
04x

3/8"

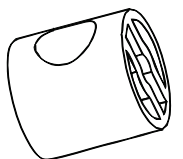

D
12x

Ø 1/4"

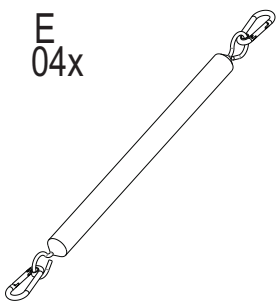

E
04x

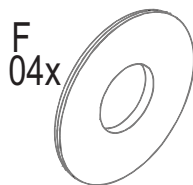

F
04x

3/8"

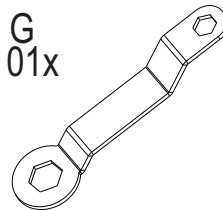

G
01x

Cab. 9/16" x 1/2"

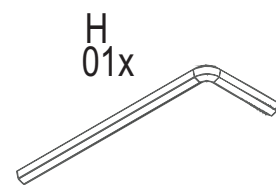

H
01x

Cab. Ø13 mm Ø 1/4"x 50mm

Bengala de exercícios direito
Qtde: 1

01

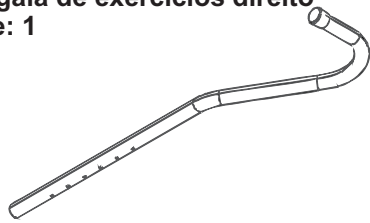

Bengala de exercícios esquerdo
Qtde: 1

02

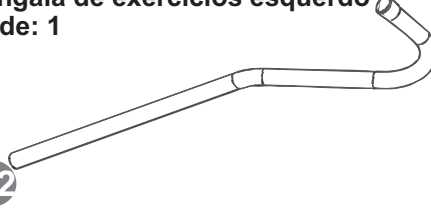

Travessa Inferior - Qtde: 1

03

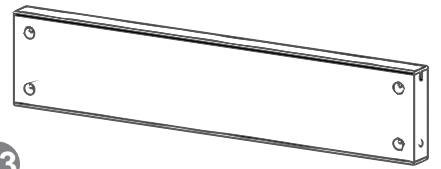

Barra de união
Qtde: 1

04

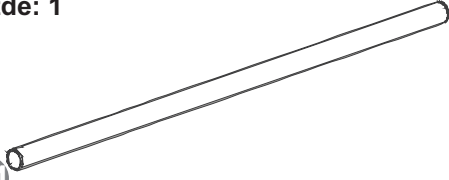

Base em madeira - Qtde: 1

05

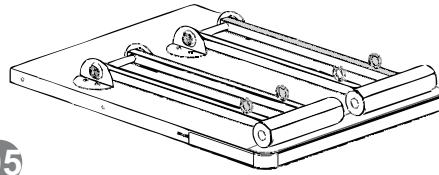

Estofado - Qtde: 1

06

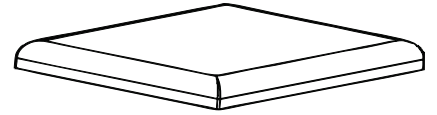

Lateral direito
Qtde: 1

07

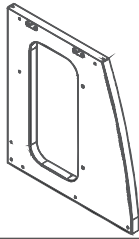

Lateral esquerdo
Qtde: 1

08

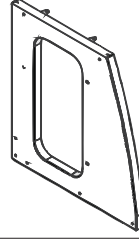

Regulagens de exercícios
Qtde: 1

09

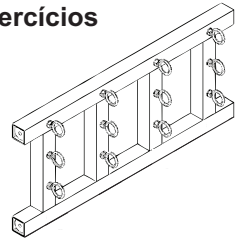

Suporte de Apoio
Qtde: 2

10

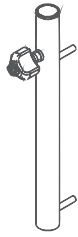

Travessa Frontal
Qtde: 1

11

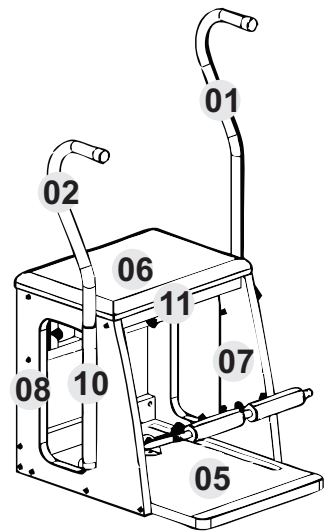
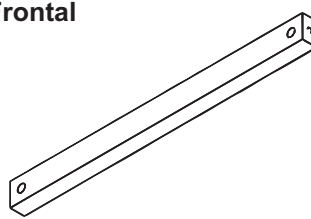

01

