

Critical Potentials Tube S with Ne-Filling 1000621

Instruction sheet

10/15 ALF

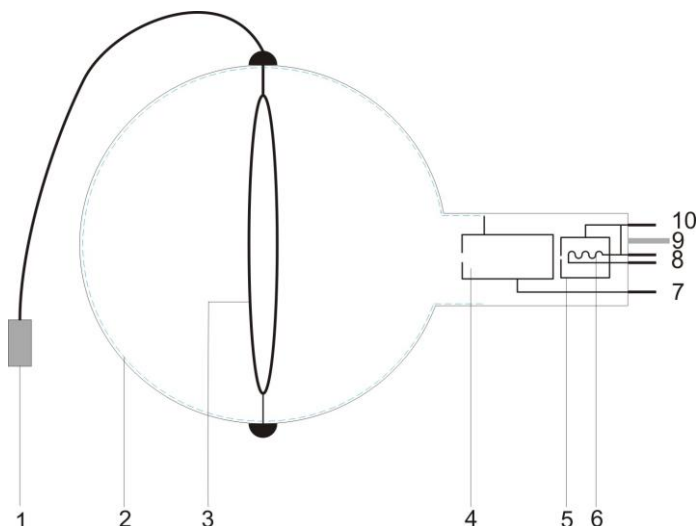

- 1 BNC jack
- 2 Glass coating at the anode voltage
- 3 Collector ring
- 4 Anode
- 5 Electron gun
- 6 Heater filament
- 7 Connection pin anode
- 8 Connection pin filament
- 9 Guide pin
- 10 Connection pin cathode

1. Safety instructions

Hot cathode tubes are thin-walled, highly evacuated glass tubes. Treat them carefully as there is a risk of implosion.

- Do not subject the tube to mechanical stresses.
- Do not subject the connection leads to any tension.
- The tube may only be used with tube holder S (1014525).

If voltage or current is too high or the cathode is at the wrong temperature, it can lead to the tube becoming destroyed.

- Do not exceed the stated operating parameters.
- Only change circuits with power supply equipment switched off.
- Only exchange tubes with power supply equipment switched off.

When the tube is in operation, the stock of the tube may get hot.

- Allow the tube to cool before dismantling.

The compliance with the EC directive on electromagnetic compatibility is only guaranteed when using the recommended power supplies.

2. Description

The critical potentials tube S with neon filling is for quantitative analysis of inelastic collisions between electrons and neon atoms and serves to determine the ionization energy and to solve primary and spin momentum quantum numbers.

The critical potential tube features an electron gun with a directly heated tungsten cathode and a cylindrical anode in a glass bulb, evacuated and then filled with neon. The inner wall of the bulb is covered with a conductive coating connected to the anode. The collector ring is situated inside the bulb in such a way that diverging electron beams cannot directly collide with it.

The battery unit provides a collector voltage U_R between the anode and the collector.

If the collector voltage is positive, only those electrons that have almost completely delivered their kinetic energy in inelastic collision with a neon atom, are deflected and accumulated to the collector. The maxima of the resulting electron current curve (collector current vs. anode voltage) correspond to the excitation energies in the neon atom.

If the collector voltage is negative, positive neon

ions are deflected and collected to the collector. The ionization energy of the neon atom can be read off from the course of the resulting ion current curve (collector current vs. anode voltage).

3. Contents

1 Critical potentials tube S with Ne filling
 1 Battery unit (battery not included)
 1 Shielding
 1 Manual

4. Technical data

Gas filling: Neon
 Filament voltage: $U_F \leq 7 \text{ V DC}$
 Anode voltage: $U_A \leq 60 \text{ V}$
 Anode current: $I_A \leq 10 \text{ mA}$
 Collector voltage: $U_R = 1,5 \text{ V}$
 Collector current: $I_R \leq 200 \text{ pA}$
 Glass bulb: 130 mm diam. approx
 Length of tube: 260 mm approx.

Critical potentials of neon:

$2p^53s^1$: 16.6 eV
 $2p^53p^1$: 18.4 eV
 $2p^54s^1$: 19.7 eV
 $2p^54p^1$: 20.3 eV
 $2p^54d^1$: 20.6 eV
 Ionization: 21.6 eV

5. Additionally required

For operating the tube:

1 Tube holder S 1014525
 1 Control Unit for Critical Potential Tubes
 (115 V or 230 V) 1000633 / 1008506
 1 DC-Power Supply, 0–20 V
 (115 V or 230 V) 1003311 / 1003312
 or
 1 Power Supply Unit for Franck-Hertz Experiment
 (115 V or 230 V) 1012819 / 1012818

For making measurements:

1 Analogue Oscilloscope 2x30 MHz 1002727
 2 HF Patch Cords, BNC/4 mm Plug 1002748
 or
 1 3B NETlog™
 (115 V or 230 V) 1000539 / 1000540
 1 3B NETlab™ 1000544
 1 computer
 1 Battery AA 1.5 V
 1 Set of 15 Safety Experiment Leads 1002843

6. Operation

6.1 Setting up the tube in the tube holder

- The tube should not be mounted or removed unless all power supplies are disconnected.
- Press tube gently into the stock of the holder and push until the pins are fully inserted. Take note of the unique position of the guide pin.

6.2 Removing the tube from the tube holder

- Allow the tube to cool before dismantling.
- To remove the tube, apply pressure on the guide pin until the pins loosen, then pull out the tube.

7. Example experiment

Determine the critical potentials of a neon atom

7.1 General notes

The experiment set-up with the critical potential tube is highly sensitive to sources of electromagnetic interference. (computers, fluorescent lights).

- Select a location for the experiment where electromagnetic interference can be avoided.

Circuit schematic

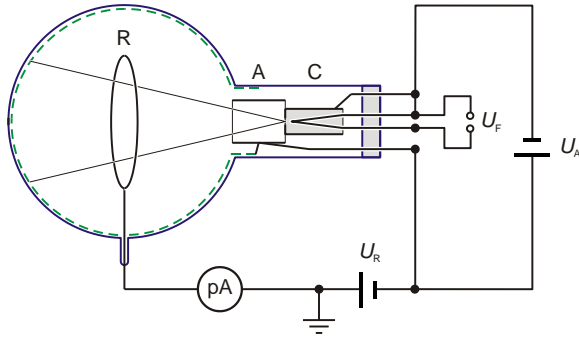

R: Collector ring
A: Anode
C: Cathode

7.2 Experiment set-up with the control unit for critical potential tubes

- Insert the tube into the tube holder.

Provision of heater voltage U_F :

- Connect the sockets F3 of the tube holder to the positive terminal of the DC power supply and F4 to the negative terminal. (see Fig. 1)

Provision of accelerating voltage U_A :

- Connect socket C5 of the tube holder to the negative terminal of the output V_A on the control unit and to the negative terminal of the DC power supply.
- Connect socket A1 to the positive terminal of the output V_A on the control unit.

Provision of collector voltage U_R :

- Put the shielding over the tube and slot it into the groove on the tube holder so that the tube is completely enclosed by shielding. Then connect the control unit by means of the ground socket.
- Connect the lead from the collector ring to the BNC input socket of the control unit.
- Clip the battery into the battery holder with the correct polarity.
- The positive pole of the output V_A should be connected to the negative pole of the 1.5 V battery.
- Connect the positive terminal of the 1.5 V battery to an earth socket on the control unit.

Note:

The collector voltage is now positive as required for recording the curve for the electron current. In this case, the current measurement values are negative.

In order to halve the collector voltage, the positive pole of the control unit can be connected to terminal B of the battery holder.

To record the ion current curve, the battery polarity is reversed in order to obtain a negative collector

voltage. The current measurements are then positive.

7.2.1 Procedure with 3B NET/log™

- At the output V_A of the control unit, set the minimum voltage to about 10 V and the maximum voltage to about 35 V, by using the 3B NET/log™ unit to measure the voltages (smaller by a factor of 1000) between socket 3 and earth and that between socket 4 and earth. Alternatively, the voltages can be set up with the help of a multimeter.
- Connect the 3B NET/log™ unit to the computer.
- Connect the output "Fast 1" from the control unit to input A of the 3B NET/log™ unit and the output "Fast 2" to input B. (See Fig. 2)
- Switch on the 3B NET/log™ unit and start the 3B NET/lab™ program on the computer.
- Select the "Measurement lab" function and open a new data record.
- Select analogue inputs A and B and DC voltage mode (VDC), setting the measurement ranges to 200 mV for A and 2 V for B.
- Enter the formula $I = -667 * \text{"Input_B"}$ (unit pA).
- Set the following parameters: Measurement interval = 50 μs , Measurement duration = 0.05 s, Mode = Recorder.
- Set triggering on the input A with rising edge (20%).
- On the DC power supply, set the heater voltage to 3.5 V.
- Start the graph-plotting of the experimental data.
- Set up the graph with "relative time t in s" on the x-axis and the quantity I on the y-axis.
- Repeat the measurements with slightly higher heater voltages and vary the minimum and maximum accelerating voltages U_A to find the optimum graph.
- In the spectrum, identify the $2p^53S^1$ peak at 16.6 eV and determine its position t_1 on the time axis.
- Identify the ionization threshold at 21.6 eV and determine its position t_2 on the time axis.
- Enter a new formula for the quantity E defined as $16.6 + 5 * (t - t_1) / (t_2 - t_1)$ with the unit eV; in this expression enter the numerical values for t_1 and t_2 in s determined as above.

- Set up a graph with the quantity E on the x-axis and the quantity I on the y-axis. (See Fig. 3).

In order to display the ion current curve, reverse the polarity of the collector voltage.

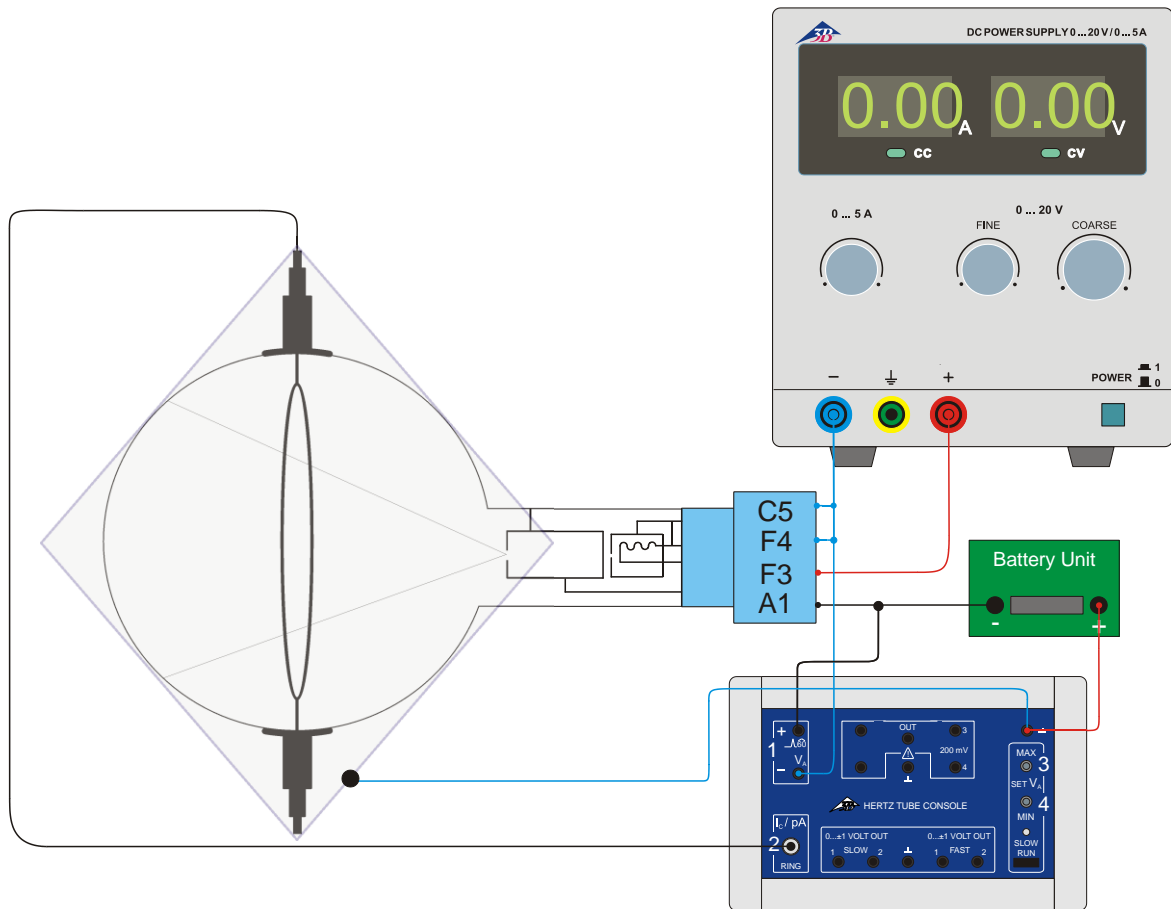

Fig. 1 Experiment set-up with the control unit for critical potential tubes

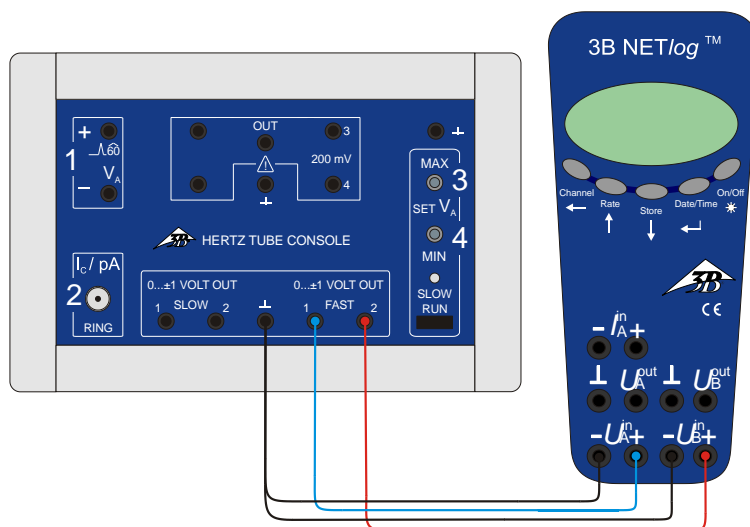

Fig. 2 Connection of 3B NETlog™ to the control unit for critical potential tubes

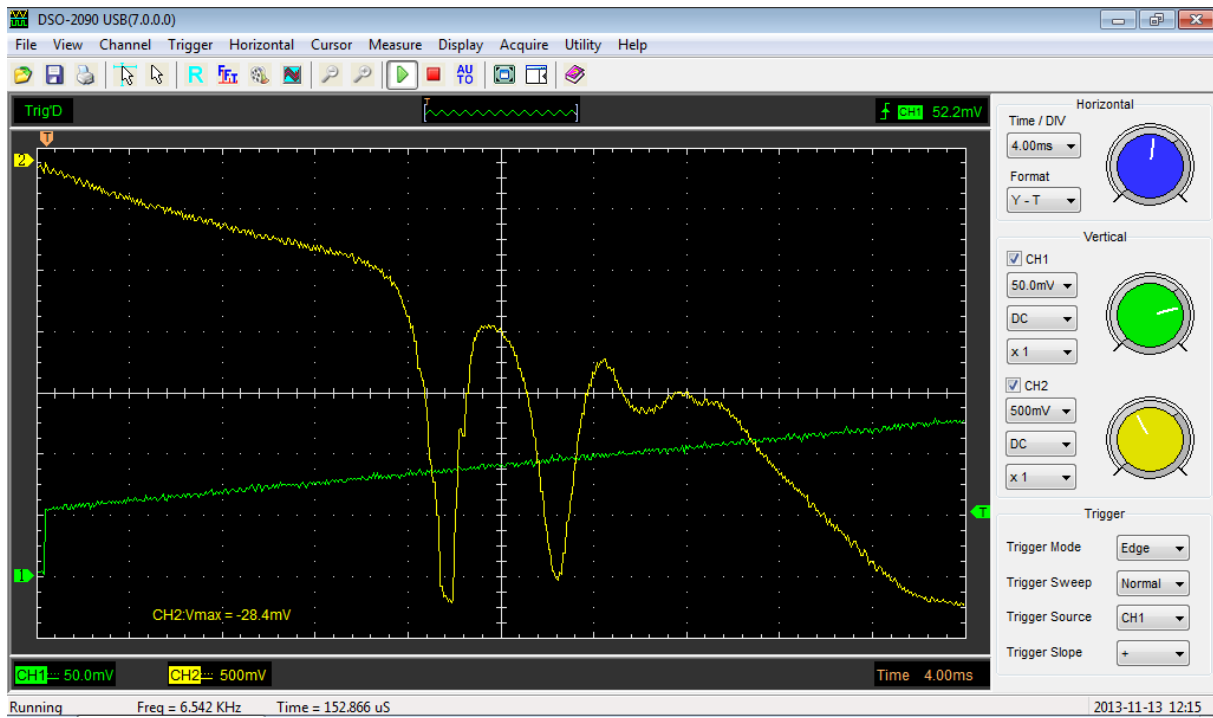

Fig. 3: Determination of critical potentials for neon atoms (curve recorded using 3B NETlog™). Excitation energies at 16,6 eV ($2p^53s^1$ -level), 18,4 eV ($2p^53p^1$ level), 19,7 eV ($2p^54s^1$ level), 20,3 eV ($2p^54p^1$ level) and 20,6 eV ($2p^54d^1$ level) and ionization energy at 21,6 eV

7.2.2 Procedure with an oscilloscope

- Connect output Fast1 on the control unit to Channel 1 (X deflection) on the oscilloscope and output Fast 2 to Channel 2 (Y deflection). (See Fig. 4)
- Set the minimum voltage output V_A on the control unit to approximately 10 V and the maximum voltage to about 35 V. Use a multimeter to measure the voltage between socket 3 and ground or socket 4 and ground, which will be a factor of 1000 times smaller.
- On the DC power supply, set the heater voltage to 3.5 V.

Oscilloscope settings:

Channel 1: 50 mV/div
 Channel 2: 0.2 V/div
 Time-base: 5 ms
 Trigger on Channel 1

- Vary the heating voltage, the upper and lower limits of the accelerating voltage and the oscilloscope parameters until the best curve can be seen.
- In order to display the ionization curve, reverse the polarity of the collector voltage.

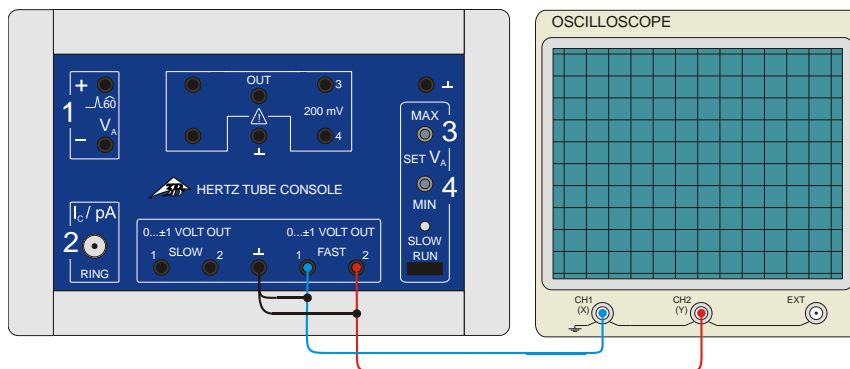

Fig. 4 Connection of an oscilloscope to the control unit for critical potential tubes

7.3 Experiment set-up with the control unit for the Franck-Hertz experiment

- Insert the tube into the tube holder.

Provision of heater voltage U_F :

- Connect socket F3 on the tube holder to socket F on the control unit for the Franck-Hertz experiment and connect socket F4 to socket K. (refer to Fig. 5)

Provision of accelerating voltage U_A :

- Connect socket C5 on the tube holder to socket K on the control unit and socket A1 to socket A.

Note:

The collector voltage U_R is supplied internally from the Franck-Hertz experiment control unit. It can be varied between 0 V and 12 V and is positive when the set opposing (decelerating) voltage is shown as negative. The values measured for the electron current are then negative.

- Put the shielding over the tube and slot it into the groove on the tube holder so that the tube is completely enclosed by shielding. Then connect it to the ground socket of the control unit for the Franck-Hertz experiment.
- Connect the collector ring to the BNC input on the control unit.

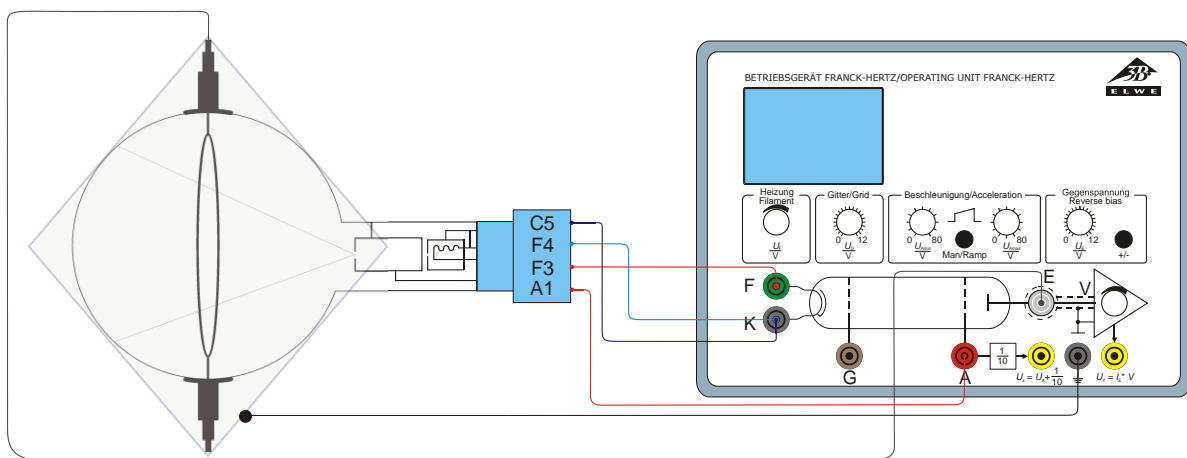

Fig. 5 Experiment set-up with the control unit for the Franck-Hertz experiment

7.3.1 Procedure with 3B NET/log™

- Connect the 3B NET/log™ unit to the control unit for the Franck-Hertz experiment (see Fig. 6). Connect the U_x output of the control unit to input A of the 3B NET/log™ unit and output U_y to input B.
- Set the control unit to ramp mode and configure a minimum voltage of about 10 V, with a maximum voltage of about 35 V.
- Select a heater voltage of some 3.5 V and a collector voltage of around -1.5 V.
- Set up the 3B NET/log™ interface, the 3B NET/lab™ computer program and the measurement recording as described in section 7.2.1.
- Vary the heating voltage, the upper and lower limits of the accelerating voltage and the gain until the best optimal can be seen.
- In order to display the ion current curve, reverse the polarity of the collector voltage.

7.3.2 Procedure with an oscilloscope

- Connect the U_x output of the control unit to Channel 1 (X deflection) of the oscilloscope and output U_y to Channel 2 (Y deflection) (see Fig. 7).
- Set the control unit to ramp mode and configure a minimum voltage of about 10 V, with a maximum voltage of about 35 V.
- Select a heater voltage of some 3.5 V and a collector voltage of around -1.5 V.

Oscilloscope settings:

Channel 1: 50 mV/div

Channel 2: 0.2 V/div

Time-base: 5 ms

Trigger on Channel 1

- Vary the heating voltage, the upper and lower limits of the accelerating voltage and the oscilloscope parameters until the best curve can be seen.
- In order to display the ion current curve, reverse the polarity of the collector voltage.

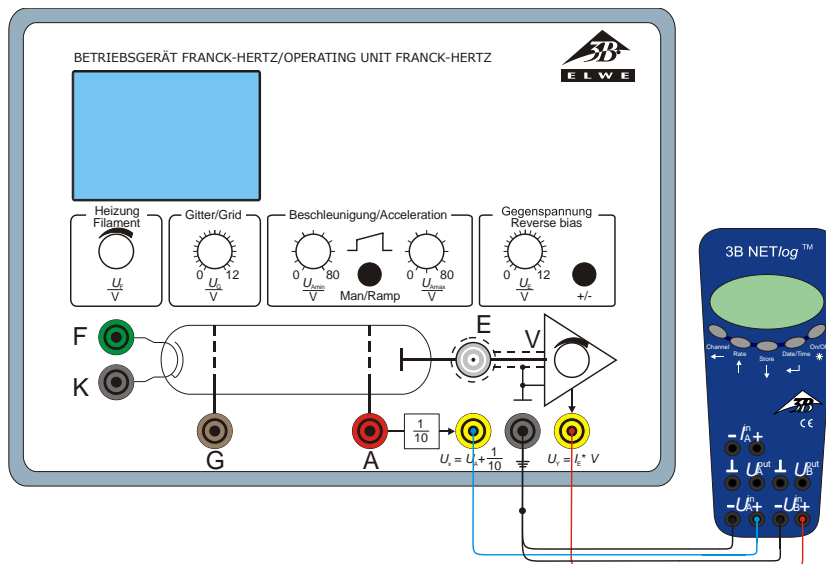

Fig. 6 Connection of 3B NET/log™ to the control unit for the Franck-Hertz experiment

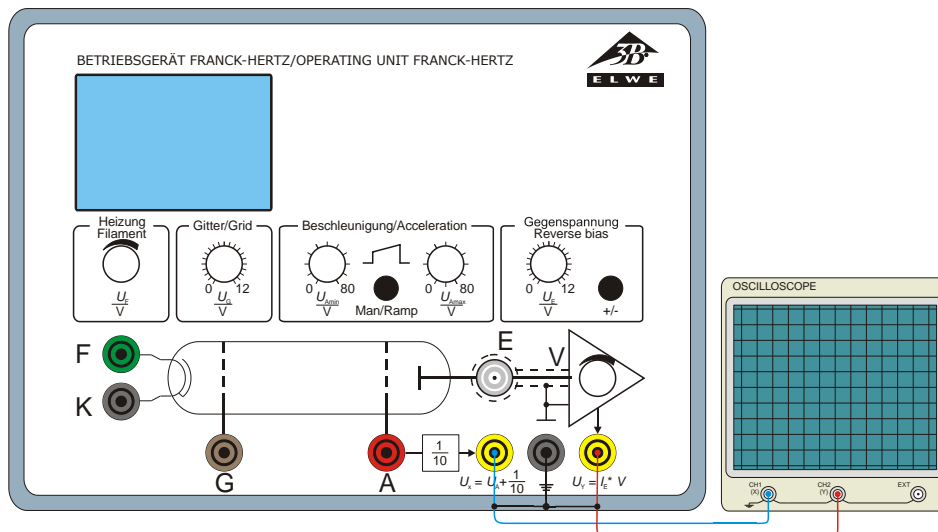

Fig. 7 Connection of oscilloscope to the control unit for the Franck-Hertz experiment

7.3.3 Calibration of measurement curve

- Set the heater voltage to 3.5 V and collector voltage to -1.5 V; set the lower limit for the accelerating voltage to 0 V and the upper limit to 60 V. Turn up the gain.

The oscilloscope screen shows a curve which has a weakly defined structure in three places. The first of these structures are of interest here. To emphasise these places, carry out the following procedure.

- Reduce the upper limit of the accelerating voltage down to about 35 V.

This zooms in on the measurement curve and the structures become clearer.

- In order to display the curve even bigger, raise either the gain or the heater voltage.

You may need to change the oscilloscope settings.

- Raise the upper limit of the accelerating voltage (to about 10 V) until the curve starts at the edge of the first peak. You may need to increase the gain to display the structures better.
- Reduce the upper limit of the accelerating voltage (to about 25 V) until the curve ends at the point where ionization begins.

The range of the curve in which the critical potentials lie is now displayed within clearly defined limits on the oscilloscope screen and the critical potentials themselves can specifically be identified.

