

## Demo Multimeter 1017895

### Instruction sheet

12/16 SD/JS



### 1. Description

The demo-multimeter is an electronic meter featuring a double scale for analog measurement of current and voltage in demonstration experiments. It is suitable for use as a free-standing instrument or for setting up in training panel frames.

The meter can handle measurements of current and voltage values and also allows the zero point to be set up in the centre of the scale for measurement of DC quantities. All the possible measuring ranges can be selected by means of a single rotary switch.

This equipment is protected by fuses and authorised for making measurements in circuits directly connected to the low-voltage mains via plugs (CAT II), i.e. for measurements on household appliances, for example. The current measuring

ranges are resistant to long-term overloading up to 10 A. Generous protection of all the current ranges by means of semiconductor circuit breakers prevents the fuse blowing unintentionally in many cases.

Switching between measuring ranges does not break any circuits connected to the equipment. This means it is possible to carry out measurements on voltage converters, for example, without causing induction surges. Resistance  $R$ , conductance  $G$ , impedance  $Z$  and admittance  $Y$  can easily be determined as quotients of current and voltage measurements thanks to the non-interrupting switch capability without the need to change the wiring.



## 2. Safety instructions

The demo multimeter conforms to safety regulations for electrical measurement, control and laboratory equipment, as specified in DIN EN 61010-1, protection class 2 and to measuring category CAT II for up to 600 V. The nominal voltage between the phase conductors and the neutral for voltage and current measurements (in circuits directly connected to mains electricity) must not exceed 600 V in order to conform to CAT II.

The meter is intended for measurements within its measuring ranges and in a measuring environment as described in detail in the course of this manual. Safe operation of the multimeter is guaranteed if it is solely used as specified. Safety cannot be guaranteed, however, if the multimeter is used incorrectly or handled without due care and attention. In order to avoid serious injury due to current or voltage shocks, the following safety instructions are to be observed at all times.

The multimeter may only be used by persons who are able to recognise the risks of contact and take due precautions to avoid them. Voltages in excess of 33 V AC (RMS) or 70 V DC are to be regarded as actively dangerous if the current, charge or energy stored should exceed certain values (see DIN EN 61010-1).

- Carefully read the instruction manual before using the multimeter and obey the instructions therein.
- The multimeter may only be used in a dry, dust-free environment with no risk of explosions occurring.

The assumption needs to be made that unforeseen voltages may be present in the vicinity of objects being measured (e.g. faulty equipment).

- Before using the multimeter, check the housing and measuring leads for damage and if there should be any malfunctions or visible damage, the multimeter is not to be used. Pay specific attention to the insulation for the measuring sockets.
- The multimeter may not be used to make measurement on circuits which exhibit corona discharge (high voltage).
- Particular care is to be taken when making measurements on high-frequency circuits where dangerous voltages may arise due to superimposition of components.
- The authorised measuring range is not to be exceeded. If measurements are made when the magnitude of the variable is unknown, always select a large measuring range before shifting down to lower ones.

- Make very sure that the voltage value between the measured contact and earth or between the ground socket and the measurement socket does not exceed 600 V.
- Before using the analogue multimeter to check that a voltage source is not exhibiting any actual voltage, check that the meter is working properly by selecting the battery test function.
- When measuring current, make sure the electricity is turned off before the analogue multimeter is connected into the circuit.
- When making measurements, always connect the ground lead first. Disconnect the signal measurement lead before unplugging the ground.
- Turn off the multimeter before opening the casing, disconnect the power to the circuit and the measuring leads from the multimeter.

If measurements are made where there are any risks of coming into contact with electricity, a second person is to be informed.

- The demo-multimeter should not be stored, set up or operated within reach of children.
- When the multimeter is used by teenagers, trainees etc., a suitable person should supervise to ensure the equipment is used safely.
- If measurements are to be made where voltages exceed 33 V AC (RMS) or 70 V DC, be especially careful and only use safety experiment leads.

### Measuring categories according to DIN EN 61010-1.

CAT I or unstipulated: Approved for measurements in circuits which are not directly connected to the low voltage mains grid (e.g. batteries).

CAT II: Approved for measurements in circuits which are directly connected, by a mains lead and plug for instance, to the low voltage mains grid (e.g. household or office appliance and lab equipment).

CAT III: Approved for measurements in circuits which are part of a building's wiring installation (e.g. stationary consumers, distribution terminals, appliances connected directly to the distribution box).

CAT IV: Approved for measurements in circuits which are directly connected to the source of the low voltage mains (e.g. electricity meters, main service feed, primary excess voltage protection).

### 3. Technical data

#### Display:

Scales:	0 ... 10, linear 0 ... 3, linear
Scale length:	160 mm
Pointer deflection:	0...90°
Electrical zero-point offset:	in all DC ranges

#### Measurements:

Voltage ranges:	0.1/ 0.3/ 1/ 3/ 10/ 30/ 100/ 300/ 600 V AC/DC
Current ranges:	0.1/ 0.3/ 1/ 3/ 10/ 30/ 100/ 300 mA AC/DC 1/ 3/ 10 A AC/DC
Input resistance:	1 MΩ AC/DC
Voltage drop when measuring current:	100 mV approx. AC/DC

#### Reference conditions:

Ambient temperature:	23 °C
Operating alignment:	Vertical
Signal form:	Sine (1% max. discrepancy)
Peak factor:	$\sqrt{2}$
Frequency range:	40 Hz ... <u>50 Hz</u> ... 5 kHz

#### Accuracy (at reference conditions):

DC quantities:	Class 2
DC with zero-point offset:	Class 5
AC quantities:	Class 3

#### Extended frequency range (class 10):

3 – 600 V:	40 Hz ... 50 Hz ... 40 kHz
0,3 – 1 V:	40 Hz ... 50 Hz ... 10 kHz
0,3 – 3000 mA:	40 Hz ... 50 Hz ... 40 kHz
10 A:	40 Hz ... 50 Hz ... 40 kHz

#### Resistance, conductance, impedance, admittance

These quantities can be determined by forming various quotients involving "simultaneous measurements" of current and voltage.

$R = U / I$ :	below 1 mΩ ... above 10 MΩ
$S = I / U$ :	below 1 μS ... above 30 S
$Z = U / I$ :	below 1 mΩ ... above 10 MΩ, 40 Hz ... 40 kHz
$Y = I / U$ :	below 1 μS ... above 30 S, 40 Hz ... 40 kHz

#### Overload protection:

Voltage ranges:	600 V long-term in all voltage ranges
Current ranges:	10 A of long-term loading in 3-A and 10-A ranges

#### Electrical safety:

Safety specifications:	EN 61010-1
Measuring category:	CAT II: 600 V
Contamination level:	2
Protection type:	IP20
Connectors:	4-mm safety sockets

#### Protection:

Fuses:	2x FF 10 A/600 V (10 x 38 mm)
Breaking capacity:	at least 10 kA
3B order number:	5008564

#### Power supply:

Battery:	1x 1.5 V, AA IEC LR6
Automatic cut-off after:	45 min ± 10 min

#### Electromagnetic compatibility:

Interference emission:	EN 55011:2009
Interference resistance:	EN 61326-1:2013

#### Operating conditions:

Ambient temperature:	5 °C ... <u>23 °C</u> ... 40°C
Storage temperature:	-20 ... 70°C
Relative humidity:	<85% with no condensation

#### General data:

Shock test:	max. 147 m/s <sup>2</sup>
Height:	297 mm
Dimensions:	259 x 297 x 125 mm <sup>3</sup>
Weight:	1,7 kg approx.

## 4. Control elements

### 4.1 Front

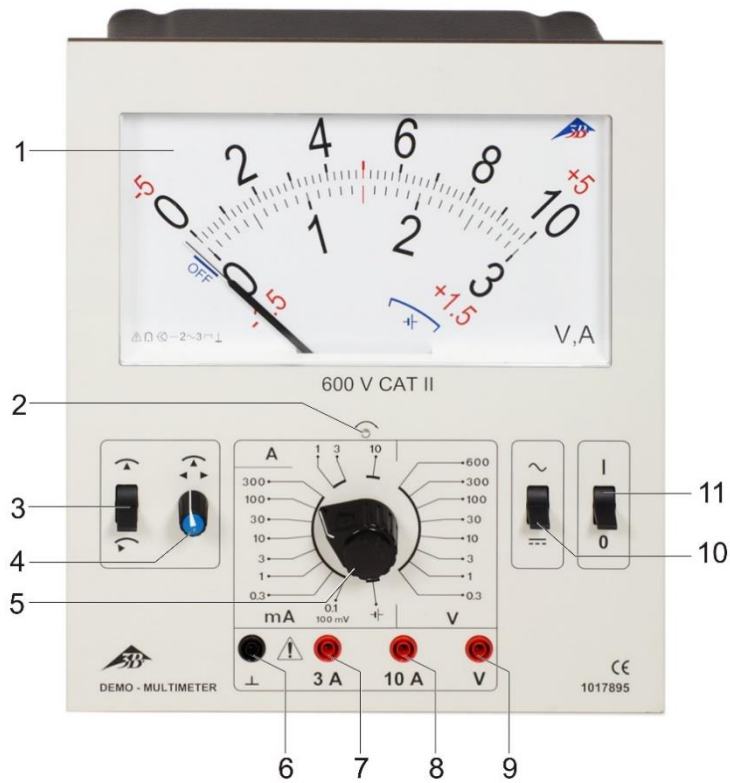

- 1 Display
- 2 Slotted screw for zero calibration
- 3 Toggle switch 1  
Zero point centre / left
- 4 Calibration trimmer for setting  
centre zero point
- 5 Rotary switch to select the mea-  
surement range
- 6 Ground socket
- 7 Current measurement socket for  
up to 3 A
- 8 Current measurement socket for  
up to 10 A
- 9 Voltage measurement socket
- 10 Toggle switch 2  
AC / DC voltage measurements
- 11 Power switch

### 4.2 Rear



- 12 Cover plate for battery and  
fuses
- 13 Rating plate
- 14 Fuse diagram
- 15 Lower edge
- 16 Feet

## 5. Symbol legend

### Display

	Hazard, read instruction sheet
	Moving coil galvanometer
	Apparatus with electronic amplifier
—2	DC quantities accuracy class 2
~3	AC quantities accuracy class 3
	Use in vertical position
<u>OFF</u>	Dial position when turned off
	Dial position for battery test when battery charge is satisfactory

### Front

	Meter on
	Meter off
	AC measurements
	DC measurements
	Zero point centre
	Zero point left
	Battery test
	Ground symbol

### Rear

	EU conformity mark
	Earth symbol
	Electrical safety assured by double insulation
	Do not dispose in normal domestic waste
	For use indoors only
	Electric fuse

## 6. Initial calibration

- Set up the demo multimeter vertically.
- Do not connect measuring leads to begin with.
- Set the toggle switch 1 to
- Set the power switch to

The needle will point to the zero point of the scale on the left. If it does not, the amount of charge of the battery should be checked.

## 7. Operation

### 7.1 To switch on:

- Set the power switch to

### 7.2 Checking battery charge:

- Turn on the demo-multimeter.
- Disconnect all measuring leads.
- Set the toggle switch 2 to
- Set the rotary switch to

If the battery is sufficiently charged, the needle will point to the following range indication, . If this is not the case, the battery will need to be replaced immediately.

### 7.3 Zero point calibration:

- Turn on the demo-multimeter.
- Turn the rotary switch to 600 V.
- Connect the common/ground socket and the voltage measurement socket together by means of a short connecting lead.
- Turn the zero-point trimmer screw to adjust the zero point as needed.

### 7.4 Zero point calibration for centre zero point:

For measurements of DC current and voltage, the zero point of the scale can be moved to the centre of the dial. For this purpose the scales are labelled with red numbers..

- Turn on the demo-multimeter.
- Disconnect all measuring leads.
- Set the toggle switch 2 to
- Set the toggle switch 1 to
- Use the zero-point trimmer to line up the needle precisely in the centre of the dial (red division).

### 7.5 To switch off:

- Set the power switch to
- Set the four-way switch to

When the meter is turned off, the needle points to OFF .



### 7.6 If a measurement is interrupted by battery cut-out:

After 45 minutes of use, the multimeter is automatically shut off and the needle will then point to OFF .

To switch back on:

- Set the power switch of the multimeter to off and then use it to turn the meter back on.

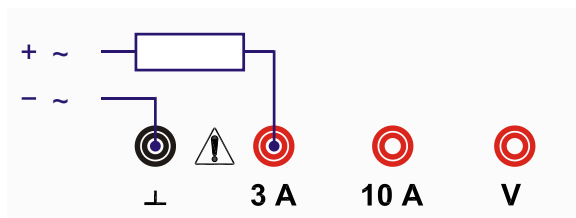

## 8. Current measurements up to 3 A

	The demo-multimeter may <b>NOT</b> be used for direct measurements on a building's electrical wiring installation or directly at the source of the mains voltage feed to the junction box. See page 2 of "Measurement categories" as specified in DIN EN 61010-1.
	<p>The nominal voltage of the current source may not exceed 600 V.</p> <ul style="list-style-type: none"> <li>The multimeter is to be connected in series with the load on the side where the voltage with respect to ground is lowest!</li> <li>Turn off the circuit before meter is connected into it.</li> </ul>



- If measurements are made when the magnitude of the variable is unknown, always select a large measuring range before shifting down to lower ones.
- Connect the terminal at the lower potential to the common/ground socket.
- Connect the common/ground lead first and only then the signal lead.



### 8.1 DC currents up to 3 A:

- Set the toggle switch 2 to .
- Alternatively, if measurements are to be made with the zero point in the centre, then set the toggle switch 1 to .
- Select the required current measuring range to a range measured in mA or A.

### 8.2 AC currents up to 3 A:

- Set the toggle switch 2 to .
- Select the required current measuring range to a range measured in mA or A.

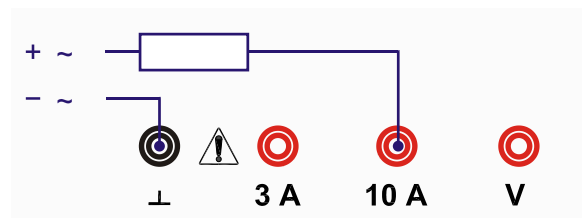

## 9. Current measurements up to 10 A

	The demo-multimeter may <b>NOT</b> be used for direct measurements on a building's electrical wiring installation or directly at the source of the mains voltage feed to the junction box. See page 2 of "Measurement categories" as specified in DIN EN 61010-1.
	<p>The nominal voltage of the current source may not exceed 600 V.</p> <ul style="list-style-type: none"> <li>The multimeter is to be connected in series with the load on the side where the voltage with respect to ground is lowest!</li> <li>Turn off the circuit before meter is connected into it.</li> </ul>



- Set up a measuring range of 10 A.
- Connect the terminal at the lower potential to the common/ground socket.
- Connect the common/ground lead first and only then the signal lead.



### 9.1 DC currents up to 10 A:

- Set the toggle switch 2 to .
- Alternatively, if measurements are to be made with the zero point in the centre, then set the toggle switch 1 to .

### 9.2 AC currents up to 10 A:

- Set the toggle switch 2 to .

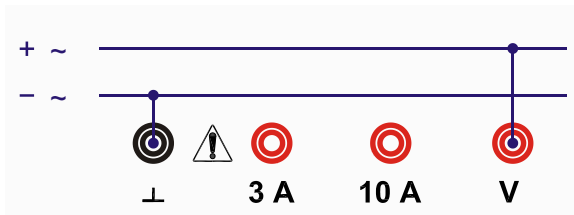

## 10. Voltage measurements

	The demo-multimeter may <b>NOT</b> be used for direct measurements on a building's electrical wiring installation or directly at the source of the mains voltage feed to the junction box. See page 2 of "Measurement categories" as specified in DIN EN 61010-1.
	The nominal voltage of the voltage source may not exceed 600 V.



- If measurements are made when the magnitude of the variable is unknown, always select a large measuring range before shifting down to lower ones.
- Connect the common/ground lead first and only then the signal lead.



### 10.1 DC voltages up to 600 V:

- Set the toggle switch 2 to .
- Alternatively, if measurements are to be made with the zero point in the centre, then set the toggle switch 1 to .
- Select the required measuring range to a range measured in V.
- For measurements of voltage up to 100 mV, set the rotary switch to the range 0.1 mA/100 mV.

### 10.2 AC voltages up to 600 V:

- Set the toggle switch 2 to .
- Select the required measuring range to a range measured in V.
- For measurements of voltage up to 100 mV, set the rotary switch to the range 0.1 mA/100 mV.

## 11. Measuring current and voltage together

	The demo-multimeter may <b>NOT</b> be used for direct measurements on a building's electrical wiring installation or directly at the source of the mains voltage feed to the junction box. See page 2 of "Measurement categories" as specified in DIN EN 61010-1.
	The nominal voltage of the current source may not exceed 600 V. <ul style="list-style-type: none"> <li>• The multimeter is to be connected in series with the load on the side where the voltage with respect to ground is lowest!</li> <li>• Turn off the circuit before meter is connected into it.</li> </ul>

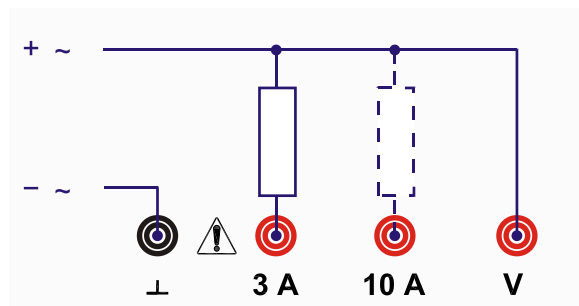

### 11.1 DC voltages and currents:

- Set the toggle switch 2 to .
- Use the rotary switch to set the desired voltage measuring range and read off the measurement.
- Set a suitable current measuring range and read off the measurement.

### 11.2 AC voltages and currents:

- Set the toggle switch 2 to .
- Use the rotary switch to set the desired voltage measuring range and read off the measurement.
- Set a suitable current measuring range and read off the measurement.

## 12. Battery and fuses

The demo-multimeter has a compartment which houses both the battery and fuses and which is accessible at the rear once its cover is opened.

One fuse each is provided for the 3 A and 10 A sockets:

FF10 A/600 V, breaking capacity: at least 10 kA (3B order number: 5008564)

The polarity is indicated by plus and minus signs inside the fuse holder compartment. A mechanical system ensures the battery makes no contact if it is inserted the wrong way round.

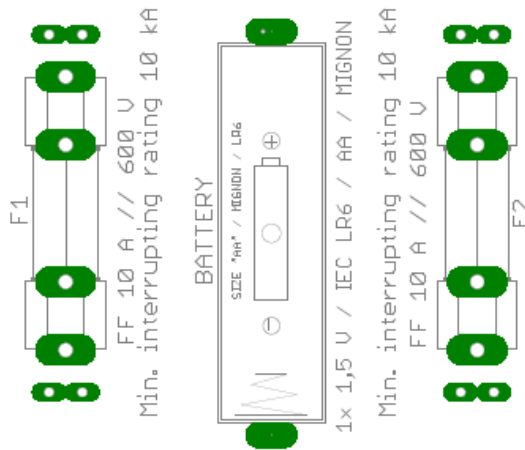

Battery and fuse compartment

### 12.1 Battery testing:

Batteries which are discharged and have not been used for a while may leak.

	<ul style="list-style-type: none"> <li>Check the amount of charge left in the battery from time to time.</li> <li>Flat or leaking batteries should be removed from the meter.</li> </ul>
	<p>If the demo multimeter goes unused for a long period:</p> <ul style="list-style-type: none"> <li>Remove the meter's battery before reusing.</li> </ul>

### 12.2 Changing the battery:

	<p>Before opening the casing:</p> <ul style="list-style-type: none"> <li>Turn off the demo multimeter.</li> <li>Disconnect all measuring leads.</li> </ul>
--	--

- Remove the cover at the rear.
- Replace flat batteries with 1.5-V alkaline batteries of size AA IEC LR6.
- Place the negative pole of the battery on the spring.
- Close the cover again afterwards.

### 12.3 Changing fuses:

	<p>Before opening the casing:</p> <ul style="list-style-type: none"> <li>Turn off the demo multimeter.</li> <li>Disconnect all measuring leads.</li> </ul>
--	--

- Remove the cover at the rear.
- Check the fuses.
- Blown fuses should be replaced with ones of the same rating.
- Close the cover again afterwards.

## 13. Cleaning

- For cleaning, use a soft cloth, slightly moistened with alcohol, or a brush.

Electrostatic charging of the display window can affect the measurements under certain circumstances:

- To remove such charge, use a soft cloth slightly soaked in alcohol or a paint brush.

Dirt or moisture in the measurement sockets can affect readings.

- Shake out any dirt that may be in the measurement sockets.
- Soak a new swab with isopropyl alcohol and work around the inside of each measurement socket.

## 14. Disposal

- The packaging should be disposed of at local recycling points.

Should you need to dispose of the equipment itself, never throw it away in normal domestic waste. If being used in private households it can be disposed of at the local public waste disposal authority.

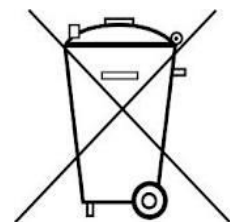

- Comply with the applicable regulations for the disposal of electrical equipment.
- Do not dispose of the batteries in the regular household garbage. Follow the applicable legal regulations (UK: Waste Batteries and Accumulators Regulations, EU: 2006/66/EC).